

*H. J. Hall*

## A Study of Stress Homogeneity in Cylindrical Cavities at High Pressures

**J. E. TYDINGS**

Research Physical Scientist,  
Institute for Exploratory Research,  
U. S. Army Electronics Research  
and Development Laboratory,  
Fort Monmouth, N. J.

*Apparatus*

**A. A. GIARDINI**

Research Physical Scientist,  
U. S. Army Signal Research  
and Development Laboratory,  
Fort Monmouth, N. J.

The stress distribution in cylindrical cavities containing talc, pyrophyllite and hot-pressed boron nitride has been determined to 60 kilobars. Pressures were measured by monitoring transitions in bismuth, thallium, and barium by electrical techniques. The work is divided into three parts: (1) A determination of the location and magnitude of stress gradients; (2) the effect of AgCl on the rate of transformation of the sensing elements as opposed to rates when the elements are surrounded only by the solid media under discussion; (3) a determination of the apparent shear strength of the pressure-transmitting materials under actual experimental conditions.

**\$ 1 PER COPY**

**50 c TO ASME MEMBERS**

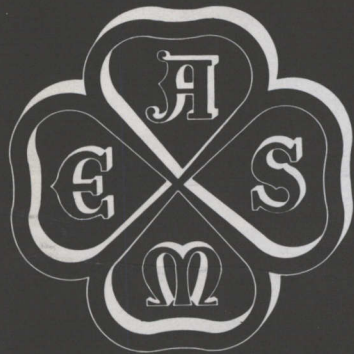

The Society shall not be responsible for statements or opinions advanced in papers or in discussion at meetings of the Society or of its Divisions or Sections, or printed in its publications.

Discussion is printed only if the paper is published in an ASME journal.

Released for general publication upon presentation

THE AMERICAN SOCIETY OF MECHANICAL ENGINEERS  
345 East 47th Street, New York 17, N. Y.

Contributed by the Research Committee on Mechanical Pressure Elements for presentation at the Winter Annual Meeting, New York, N. Y., November 25-30, 1962, of The American Society of Mechanical Engineers. Manuscript received at ASME Headquarters, October 4, 1962.

Written discussion on this paper will be accepted up to January 10, 1963.

Copies will be available until October 1, 1963.



# A Study of Stress Homogeneity in Cylindrical Cavities at High Pressures

J. E. TYDINGS

A. A. GIARDINI

With the development of apparatus capable of generating pressures in excess of 30 kilobars (kb), solid pressure media have come into widespread use. A study of the characteristics of three solids suitable as pressure transmitting media, viz., pyrophyllite, talc, and boron nitride is the subject of this paper.

The authors are aware of the limitations and qualifications inherent in work of this nature and a brief discussion of these points is desirable before proceeding with the text. In view of the fact that nonhydrostatic systems are being considered, the geometry of the working cavity, frictional properties of the materials chosen, and operating characteristics of the pressure device utilized will all influence the distribution of stress.

During the past 5 years, working experience has been acquired with the following classes of apparatus: (a) moderate (1 cu in.) volume multianvil equipment of tetrahedral configuration; (b) large (6 cu in.) volume multianvil apparatus of cubic configuration, and (c) moderate (1 cu in.) and small (0.1 cu in.) volume piston-cylinder devices. Owing to the extrusion inherent to the formation and compression of gaskets in multianvil arrangements, serious sample deformation usually is encountered. It has been found, however, that properly shaped and dimensioned "preformed" gaskets dramatically reduce deformation and at the same time increase both the upper pressure limit and useful life of carbide anvils. This is a direct consequence of the uniformly graduated support pressure provided by relatively thick, "resilient" gasketing over the full tapered faces of all anvils.

In spite of the marked reduction in specimen deformation realized by the use of "pregasketing", some distortion persists. Actual stress gradients, however, probably lessen considerably once gaskets are completely formed, nevertheless, the limitation of calibration element placement still must be considered.

In a properly designed piston-cylinder device, extrusion from the sample volume is virtually eliminated. Pressure-calibration specimens may be positioned at any point without fear of relative displacement. It is primarily for this reason that this paper will be confined to the prob-

lem of pressure distribution within cylindrical cavities.

Another factor tending to complicate work in this area is the frequent lack of physical uniformity in the minerals, talc and pyrophyllite. Of the two, pyrophyllite is the worst offender. While no serious attempt has been made to correlate any readily determined physical or chemical property (e.g., density) with transmission efficiency, experience has shown that it is possible to predict qualitatively the performance of pyrophyllite simply from appearance, feel and machinability. It has been observed that fine-grained, relatively dark-gray specimens which machine to a smooth, uniform surface finish display the best ability to flow under pressure. Lighter colored, "grittier" pieces yielding a rougher finish display significantly higher surface and internal friction, require higher operating forces for equivalent pressure generation, and result in larger nonhydrostatic components under load.

Talc, although showing less variation than pyrophyllite, nevertheless, yielded more scatter in data than hot-pressed boron nitride. The boron nitride would be expected to give more consistent results since it is a synthetic and therefore of more uniform composition.

Three avenues of approach were used in dealing with the problem of stress distribution in cylindrical cavities. In the first series of experiments small Bi sensing elements were placed in different positions throughout the sample in an effort to determine the magnitude and location of gradients within the cell.

A second sequence of experiments was performed to determine the nature of the effect of jacketing sensing wires with AgCl, as opposed to placing them bare in the solid media. This series was deemed necessary after the distribution of axial gradients in the first series of runs was observed. It has been suggested that the slower reaction of the Bi I-II and II-III transitions in unjacketed samples was due to gradients along the axis (1).<sup>1</sup> The axial pressure distribution pres-

<sup>1</sup> Numbers in parentheses designate References at the end of the paper.



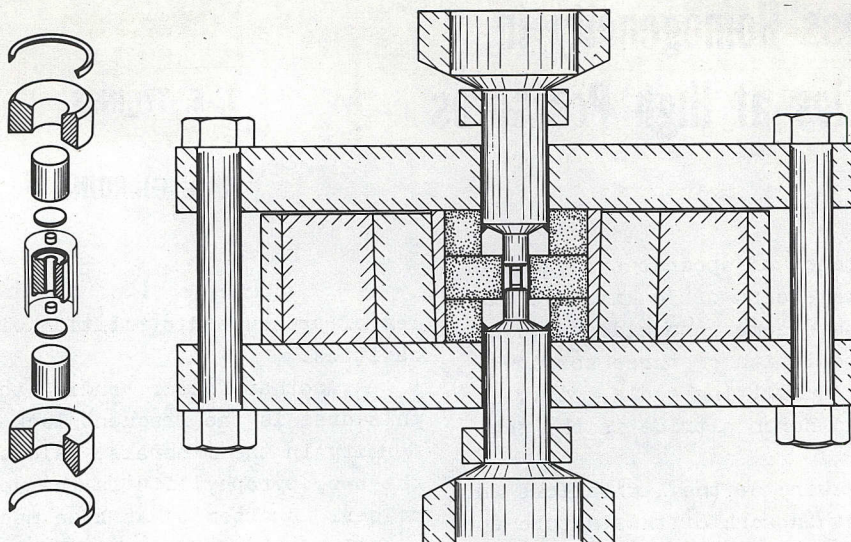

Fig. 1 Cross-sectional view of apparatus

ent in our experiments, however, was not nearly severe enough to account entirely for the marked sluggishness of these reactions. This effect appears to be due primarily to the inability of the three pressure media examined to follow the volume reduction of the transitions as rapidly as AgCl.

The third series of experiments was conducted to study the shear strength of these materials under actual operating conditions. This was accomplished by placing the sensing elements, which were extruded wire, 90 deg to one another within the cell. One sensing circuit was oriented parallel to the axis of thrust while the other was placed perpendicular to the axis.

#### EXPERIMENTAL

Fig. 1 is a cross section of the apparatus used in this work. It is a two stage, piston-cylinder device and has been fully described elsewhere (2). A 1000-ton-capacity hobbing press was used to supply the operating force. Pressure was read on a Marsh 5000 psi "Mastergage" accurate to 0.5 percent over the entire range.

The pyrophyllite tested was of domestic origin, available as Grade A lava from the American Lava Company. Talc specimens were obtained from the same supplier, but imported, and designated as Lava, Grade 1136. The hot-pressed boron nitride was obtained from the Carborundum Company.

Bi, Tl, and Ba were used as sensing elements. All were chemically pure, and extruded into 0.013 or 0.025-in-dia wire before use. Transitions were monitored by impressing a potential across the sample and tracking the change in voltage drop

with Varian G-11A strip-chart recorders. Transition values of 25.3 and 26.8 kb for Bi, 37 kb for Tl, and 59 kb for Ba were used (3). It was assumed that the transition had been reached at the midpoint of the maximum slope of resistance change.

It was apparent from past experience that the variable character of the materials used as pressure and support media caused uncertainty in the force necessary to reach a desired pressure. The uncertainty for our apparatus can be as great as  $\pm 15$  percent, and it was recognized that this effect could obscure differences in pressure which might exist at different points within the cell. To overcome this problem, two calibration samples were monitored simultaneously, each positioned at different locations within the sample holder. Ideally, of course, a study of this kind should be performed with simultaneous readings of as many sensing devices as deemed necessary. The design of the apparatus, however, permits only two circuits with the low electrical resistance necessary for calibration work.

Fig. 2 illustrates the circuitry employed. Both pistons and the cylinder were used as leads. Electrical insulation between the second-stage pistons and the high-pressure cylinder is provided by a 10-mil-thick nylon sleeve illustrated at the left in Fig. 1. For this study, one calibration specimen was connected from one piston to the cylinder while the other made contact with the cylinder and the remaining piston. Cylinder connections were made by cutting a hole in the nylon liner and bringing gold leads from the sensing wire out through this opening. In this manner it was possible to connect the specimens in either a



series or parallel circuit. Fig.2(a) shows the parallel and Fig.2(b) the series circuit used.

When an imbalance in loads existed because of differences in contact resistance or wire length, the parallel circuit was utilized. A decade box was placed in series, in each loop, as a voltage divider to equalize the potential drop across the samples. When loads were equal the circuit was connected as shown in Fig.2(b). In this instance, the two sensors were connected in series through the cylinder, which also was used as a common terminal for the meters. A constant-current supply was used in this circuit and a constant-voltage supply was used for the parallel arrangement. The use of two independent calibration samples permitted observation of pressure differences within the cell as small as 1 percent.

Standard procedure for each experiment was as follows: Force was applied slowly and evenly, and recorded every 2 tons on the charts with event pens. No stops were made until the desired transitions had been achieved. The maximum pressure was held momentarily and then lowered in the same manner in which it was applied. All results are based on readings made on the first increasing pressure cycle.

It is often stated that friction in hydraulic rams is "symmetrical"; i.e., the same with both increasing and decreasing pressure. It is of interest to note that some semi-quantitative strain measurements made with our press showed a rather large hysteresis effect.

## RESULTS AND DISCUSSION

### Determination of Gradients Within the Cell.

The sample configuration for the first series of experiments is illustrated in Fig.3(a). Thirteen mil Bi wire was placed in 0.125-in-dia x 0.025-in-thick AgCl disks drilled at 45 deg to the vertical axis to receive the Bi. A thin disk of AgCl was chosen in order to reduce the possibility of gradients existing across the Bi. Two disks were placed at varying points along the axis to determine pressures existing at different points within the cell.

Most of the experiments were run with samples 0.500 in. dia x 0.400 in. long, the size normally used in our physical chemistry work. Additional studies with 0.500-in-dia cells having heights of 0.500, 0.750 and 1.000 in. were conducted to determine the influence of wall friction on the pressure drop along the axis. The apparatus was modified somewhat for all experiments with samples longer than 0.400 in., permitting only one piston to advance. This further accentuates the frictional loss.

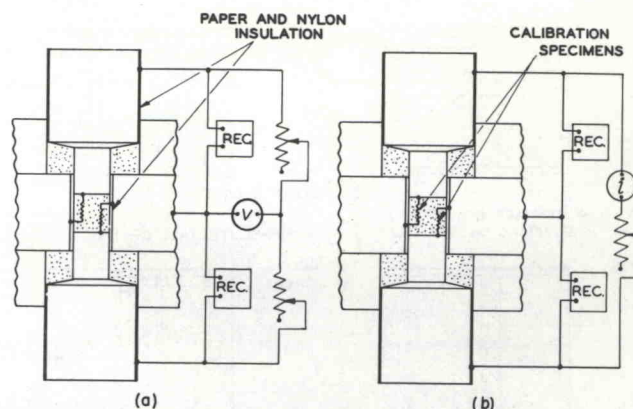

Fig. 2 Methods used for monitoring transitions for two independent circuits

The first investigations were performed to determine whether the pressures were equal at the piston faces and at points equidistant from the pistons along the axis. Specimens were placed flush with and 0.050 and 0.100 in. from each of the pistons. No detectable difference between the Bi I-II or II-III transitions was observed in any of the runs, indicating a symmetrical distribution of pressure with reference to the center of the cell.

Next, one disk was placed at the midpoint of the axis and compared with the response at the three previously mentioned positions. It was observed that the highest pressure invariably occurred at the center of the cell. The most marked difference noted was 4 percent in the case of the lava sample. Talc gave a pressure differential at 3 percent and the BN less than 1 percent. The direction of change was unexpected. A decrease in pressure with increasing distance from the pistons was anticipated. The effect apparently is due to the surface friction at the cell-piston interface.

When cylindrical specimens of brittle material are loaded in axial compression, the friction between the test piece and the loading device restricts lateral expansion of the specimen near the interface (4). This causes a barreling of the cylindrical surface and a subsequent nonuniform distribution of compressive stress near the ends. The mode of failure under these conditions is a splitting off of conically shaped pieces. The ends of the cylinder form the base of the cones. Additional stress forces the cones to wedge into the cylinder and split the specimen. A similar effect apparently takes place in confined cylinders. The conical wedge, in this case, acts as an intensifier thereby raising the pressure between the ends of the opposing cones. The base angle of



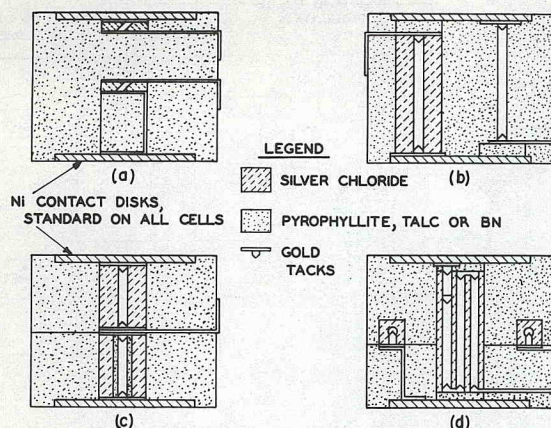

Fig. 3 Cell configuration. Sample size - 0.500-in. dia x 0.400-in. high

the cone is dependent upon both the friction at the interface and the height/width ratio of the cylinder. The height/width ratio was constant, in these tests. The only variable was the surface friction of the cell material used. The foregoing interpretation is given additional justification by the fact that BN, which has the lowest surface friction of the materials tested, showed practically no axial pressure gradient.

Our study was carried only to the low Bi transitions and the magnitude of this effect at higher pressures is still unknown. Also, the addition of samples (e.g., furnaces, etc.) along the cell axis may change the distribution of pressures in the cavity.

Using the cell lengths previously mentioned, the relative magnitude of the axial pressure drop for the three solids was then determined. Nylon was the only material used between the sample and cylinder wall, Fig. 1. No additional lubrication was provided and, as stated before, one end of the cylinder bore was closed with a stationary plug. Under these conditions, the pressure drop from the end at the moving piston, to the end at the plug, is roughly equivalent to the drop from either end to the center in a double-ended design, provided the sample in the latter case is twice the length of that used in a single-piston design.

Calibration samples were placed 0.060 in. below the face of the cell at either end. The results are given in Table 1. For samples 1 in. high, the pressure differential at the Bi I-II point varied from a high value of 30 percent for talc to 13 percent for BN. (It might be mentioned here that all BN specimens were compressed along the same direction in which the material was hot-pressed. The known directional properties of this

Table 1 - Pressure Drop From Moving Piston to Cylinder Closure in  $\frac{1}{2}$ -in.-dia Samples at Bi I-II Transition.

Material	Sample height, in.		
	1/2	3/4	1
Talc, pct.....	4.5	17	30
BN, pct.....	2.5	4.7	13
Pyrophyllite, pct.....	2.7	16.7	28

substance might have some effect on its pressure-transmitting properties. Indications of this are discussed later in the paper). That these differentials are due almost entirely to surface friction between the cylindrical surface of the sample and cylinder wall was readily verified by using 0.005 in. lead foil for lubrication, as suggested by Boyd and England (5). A 0.750-in.-high lava sample showed a change from a 17 percent difference in pressure to less than 1 percent. The surprising thing is that the material in contact with the wall will support so much thrust. For a 1-in.-high sample, the initial circumferential surface area is 1.57 sq in. At the Bi I-II point there is a difference of 93,000 psi, in the talc specimen; from the pressure at the moving piston to that at the stationary plug. The material near the wall therefore is sustaining an average shear stress of about 60,000 psi. It would be interesting to measure this effect at higher pressures, e.g., the Tl or Ba point, but since this particular series of experiments was carried out in an unsupported piston modification of our apparatus, the large pressure differential at higher calibration points results in piston failure before both specimens have transformed.

Coating the surface with  $\text{MoS}_2$  decreased the gradient from 17 to 12 percent for a 0.750-in.-high lava cell. It is clear, however, that in samples with a height/width ratio greater than 1, a relatively thick jacket of low shear material must be used if large losses are to be avoided.

Effect of AgCl on Transition Rates in Bi, Tl and Ba. The sluggishness of the Bi I-II and II-III transitions that occurs when Bi is not embedded in AgCl, has been attributed to gradients existing along the cell axis (1). Our studies of the axial-pressure distribution have shown, however, that the sluggishness could not solely be accounted for by the existence of gradients. The problem was investigated further.

Three experiments were run with each material using the configuration illustrated in Fig. 3(b). The results were qualitatively the same for each substance. A typical comparison of the response



Table 2 - Percentage of Additional Force Necessary to Reach Bi II-III Transition With Reference to Force Needed When Bi is Jacketed in AgCl.

Experiment	Material		
	Talc, pct	BN, pct	Pyrophyllite, pct
(a).....	11.2	13.6	13.5
(b).....	10.5	14.4	15
(c).....	9.5	14.6	18

is shown in Fig.4. In every experiment the un-jacketed sample began the transformation before the jacketed wire. The effect was small (on the order of 2-3 percent), and no correlation between the three materials could be discerned. The onset of the transition was very slow however, and with the application of additional force, the jacketed wire would transform rapidly in the usual manner, completing the I-II and II-III transitions before the unjacketed sample had finished the change from I-II.

A comparison of the force necessary to reach the Bi II-III transition with jacketed and bare specimens showed a definite trend. The differences in behavior for the three solids discussed is given in Table 2 in terms of the percentage of additional force needed to run the transition in the bare wire. Based on the extent of the axial gradients given earlier, BN should show the least deviation from the "ideal" response obtained with AgCl. Talc, however, showed a marked superiority in this regard, with the average of the three runs being only 10.4 percent as opposed to 14.2 percent for BN. The results with pyrophyllite were capricious, as has been our experience with this material.

Another experiment was then conducted using a 25-mil-dia x 25-mil-high Bi slug embedded in the center of a lava cell. The volume ratio between the Bi and lava was 1:6400. This was done to establish further the fact that uneven pressure distribution was not the only cause of the sluggish response. A comparison of this result with that obtained from a similar experiment having the Bi surrounded by AgCl confirmed the point. A large "overpressure" was still needed to run the transitions in the bare specimen.

It appears from the results that the determining factor is the ability of the solid media surrounding the sensing element to flow rapidly on a microscopic scale. If the material does not follow the rapid volume reduction to maintain pressure as the phase change occurs, pressure is reduced in the area immediately surrounding the calibration specimen.

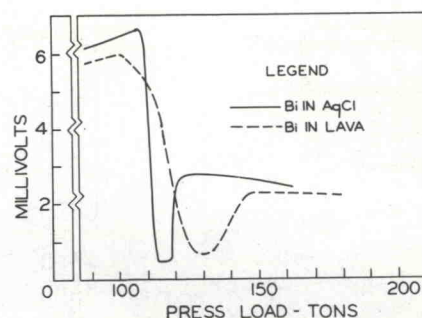

Fig.4 Comparison of response of Bi I-II and II-III transitions in jacketed and un-jacketed samples

To verify this interpretation, experiments were conducted using the configuration shown in Fig.3(c). Half the sample was loaded in the usual way, with Bi in the bore of a AgCl tube. The other half contained a thin sleeve of lava, talc, or BN which separated the Bi from the AgCl. The dimensions were: AgCl 0.125 in. od x 0.050 in id, intermediate sleeve of pressure media 0.050 in. od x 0.025 in. id, and Bi wire 0.025 in. dia.

Results from these experiments were the same as those previously discussed except that the magnitude of "overpressure" was reduced. The figures obtained were 8.7, 9.1 and 11.2 percent for talc, BN, and pyrophyllite, respectively. An additional test run with a 0.005-in-wall pyrophyllite sleeve separating the Bi wire from the AgCl sleeve yielded a response significantly more sluggish than that obtained with AgCl alone. The "overpressure" needed in this case was 6.3 percent. The inability of pyrophyllite to flow in sections as small as this should be of significance to workers using Bridgman anvil devices.

As an additional confirmation, the experimental configuration of Fig.3(b) was used with Tl as the sensing element. For the interpretation to be correct, the sluggishness of this transition should be less marked than the Bi I-II transition since the volume change is smaller by a factor of five. The result was as anticipated. The overpressure necessary to complete the Tl transition was only 4.6 percent when embedded in lava.

The increase in resistance of Ba at 59 kb, which is concurrent with a volume reduction of 1.9 percent, was observed in the pyrophyllite cell shown in Fig.3(b). Although both the jacketed and bare specimens started transforming at the same tonnage, the response from the bare specimen was so sluggish that even qualitative results were impossible to obtain. Since the nature of axial gradients have not been studied at this pressure,



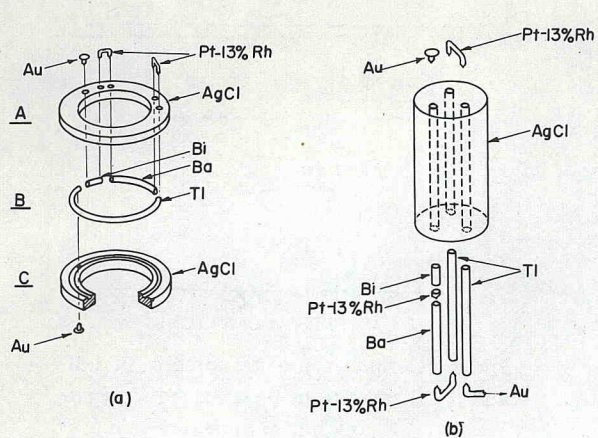

Fig. 5 Exploded views of Bi-Tl-Ba calibration-cell construction

it is not possible to judge whether the sluggishness is dependent primarily upon an inhomogeneity of pressure or restricted flow of the lava.

Two additional investigations using the experimental procedure outlined in this section merit brief discussion.

An evaluation of the directional properties of BN was conducted, using the general configuration of Fig. 3(c). The cells were made by cutting mutually perpendicular specimens from a 3-in-dia hot-pressed rod. Half the cell was turned with its longitudinal axis parallel to the direction of hot-pressing, while the remaining half was oriented with its axis perpendicular to this direction. Unjacketed Bi wires were placed along the cell axes. Two experiments were performed for each orientation. Bismuth in the half cut parallel to the hot-pressing direction responded at lower tonnages (~3 percent) and transformed somewhat faster, thus indicating lower compressibility and better flow properties in this direction. A further test of anisotropy was made by comparing a parallel specimen from the 3-in. rod with a similar piece from 1/2-in-dia stock. (This latter material was used in all other experimental work reported in this paper.) The performance of the half-cell from the 1/2-in. rod was found to be markedly superior. Response of the Bi transitions began at a tonnage 6 percent lower and ended 7.5 percent lower than in the piece cut from 3-in. stock. Whether this was due to a difference in the grain size or orientation of the BN, or to an inconsistency in the borate binder has not been determined.

Finally, a comparison was made between AgCl and indium. The configuration of Fig. 3(b) was utilized except that the bare wire was encased in a 0.125-in-dia In sleeve. Short-circuiting was prevented by using enameled Bi wire and 0.015-in-

thick AgCl disks on either end. There was no detectable difference in the response from the two circuits.

Effect of Sensor Orientation on Observed Pressures. Early in the course of calibration work it was found that sensing wires oriented perpendicular to the cell axis gave lower readings than those positioned along the axis. Since this is a measure of nonhydrostatic components and also a qualitative indication of the shear strength of solid media under actual experimental conditions, it was deemed desirable to explore this effect more fully. Three experiments with each material up to the Ba transition were made.

The previously discussed reasons for using dual-calibration circuits when comparing small differences in pressure within a cell also contribute to uncertainty when extrapolating between fixed pressure points with values obtained from different set-ups. Since the uncertainty involved might easily equal or exceed the effect under study, a method of observing two or more fixed pressure points per experiment is desirable. A technique for assembling calibration cells incorporating Bi, Tl and Ba has been developed. Although the standard methods of cell assembly incorporating single elements are well known, no mention is given in the literature of methods for assembling these elements in tandem or triplicate. A brief description of this technique therefore seems warranted.

Fig. 5 illustrates the two types of assemblies used. The circuit placed perpendicular to the cell axis is a AgCl ring which contains the sensing wires. The three-wire assembly for monitoring response parallel to the axis is a 0.125-in-dia AgCl rod. Holes are drilled 120 deg apart at the midpoint of the radius to receive the wires.

An exploded schematic of the annular assembly is shown in Fig. 5(a). Parts A and C are rings of AgCl 0.440-in. od x 0.300-in. id x 0.035-in. thick. A depression in one face of each ring is provided to accept the 0.025-in-dia sensing wires labelled B. Wire lengths were chosen to give equal resistance per element based on their resistivities at 20 C and atmospheric pressure. The "tacks" and "staples" illustrated are gold and Pt-Pt13 percent Rh, respectively. The gold is used for external contact with the Bi and Tl while the PtRh is used to connect Bi to Ba and Ba to Tl. It was found necessary to substitute Pt-Rh for gold in this instance because gold was not hard enough to pierce the oxide coating of the Ba and assure a low contact resistance.

The sequence of assembly for this cell was as follows: (a) The proper amount of AgCl powder was compacted in a die at a pressure just suffi-



Table 3 Response of Calibration Circuits Placed Parallel to and Normal to the Direction of Thrust in Cylindrical Samples. Data are Shown for Three Experiments With Each Material. Numerical Values are Tonnages of Which Transitions Occurred. See Text for Details

Transition	BN		Talc		Fyrophyllite	
	Normal	Parallel	Normal	Parallel	Normal	Parallel
Bi I-II	150	150	129	131	118	120
Bi II-III	162	162	141	142	126	128
Tl	230	230	199	207	186	196
Ba	380	380	359	368	355	365
	(See Fig. 7)		(See Fig. 7)			
Bi I-II	148	146	114	116	130	135
Bi II-III	160	158	124	126	142	145
Tl	221	224	190	192	203	212
Ba	366	368	350	352	365	374
						(See Fig. 7)
Bi I-II	126	124	110	112	116	121
Bi II-III	139	137	120	121	124	130
Tl	196	198	168	176	176	196
Ba	352	346	300	300	334	374

cient to form rings; (b) precut, prebent wires were placed in the depression between the rings with about 1mm clearance between the ends; (c) the wire-ring assembly was reloaded in the die and pressed to 125,000 psi. After ejection from the die, the wires were located by passing light through the assembly and holes were drilled to receive the contact "tacks" and connecting "staples." These holes were drilled to the midpoint of the wire axis to insure that the tacks and staples pierce fresh metal when pressed into the ring. Low contact resistance was thereby assured. The entire assembly with connections in place was again pressed to 125,000 psi, forcing the connections into the wires and sealing the holes to prevent oxidation of the Ba and Tl. Cells generally were used immediately after assembly; however, on one occasion a completed assembly was stored overnight in air with no adverse effects.

The three-wire cell used to monitor response parallel to the axis of thrust is shown schematically in Fig.5(b). Bi and Ba occupy one hole with the lower resistance Tl filling the remaining two. As in the previous discussion, gold was used to provide contact with Bi and Tl, while Pt-Rh was utilized for the connections between the elements. After positioning the wires and connectors, the assembly was pressed in a die to 100,000 psi.

A cross section of an assembled cell with both calibration circuits in place is shown in Fig.3(d). Electrical contact with the pistons and the cylinder was made with gold wire and strip.

A tracing of the typical response from one of these cells is shown in Fig.6. This was plot-

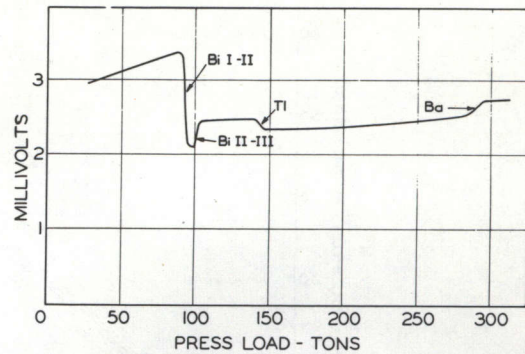

Fig.6 Tracing of response obtained from Bi-Tl-Ba cell

ted on a Houston Instruments HR-93 X-Y recorder. The MV drop across the sample was recorded on the abscissa and pressure on the hydraulic run recorded on the ordinate. A Baldwin SR-4 transducer was used to drive the pressure axis. The four transitions are easily recognized.

Results from nine experiments are listed in Table 3. These values were observed on the increasing pressure cycle. The downward results will not be considered because the press hysteresis is not accurately known. An examination of this table immediately reveals two points: (a) There is a definite difference in the behavior of the solid media when examined by this technique, and (b) the experimental method appears to be subject to an inconsistent error.

With respect to the first point, hot-pressed boron nitride is somewhat lower in shear strength at elevated pressures than talc, and significantly lower than lava. Boron nitride was the only material tested in which the calibration circuit placed parallel to the axis responded at lower tonnages than sensors perpendicular to the thrust direction. The effect was small, and inconsistent with the results discussed in Section B. Although the directional properties of the 1/2-in. stock have not been established, a tentative explanation for this behavior is as follows: The preferred planar direction of the BN platelets in hot-pressed specimens is perpendicular to the direction of hot-pressing. Since these specimens were compressed in the same direction as in the molding operation, there is probably a tendency for the platelets to slip radially toward the cavity occupied by the AgCl tube. This could result in the slightly higher pressures experienced by this circuit at some of the transition points. Also, it is possible that the more complicated cell construction used for these tests give rise to pressure gradients not found in the simpler cells of the section,



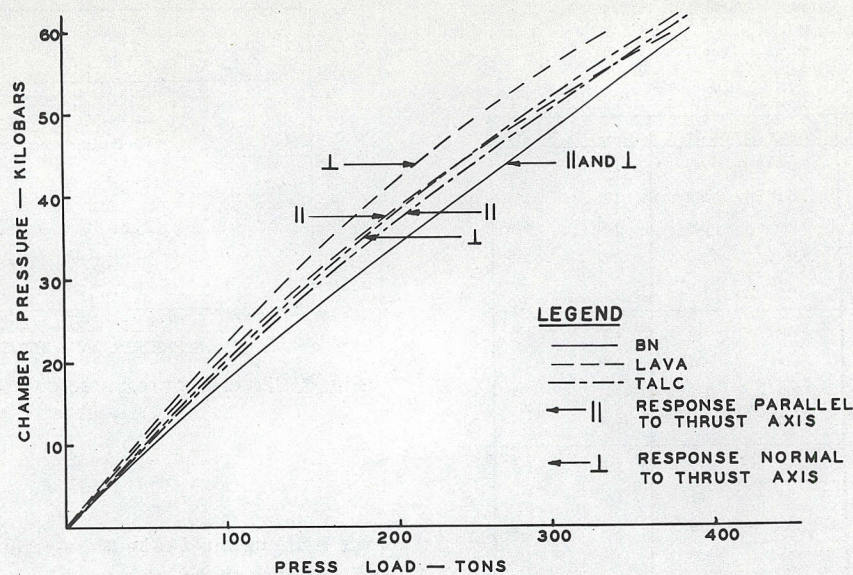

Fig. 7 Calibration curves for selected pyrophyllite, talc, and hot-pressed BN samples. Numerical data given in Table 3

#### "Determination of Gradients Within Cell."

Another interesting feature of hot-pressed BN is its high compressibility at moderate pressures.<sup>2</sup> This is shown by the higher tonnage values needed to achieve the Bi and Tl transitions. This initial high compressibility tends to decrease at higher pressures. A comparative calibration curve for representative samples of each

<sup>2</sup> Although no direct attempt has been made to determine the compressibility of the materials under discussion, their relative compressibilities can be ascertained in the following manner: In a supported piston-cylinder apparatus, the applied load is divided between the high-pressure cell and the support volume. Assuming the dimensions of all components are held constant, as they were in these experiments, the relative compressibility between the material used for support and the material used for the cell is the primary factor influencing the division of load between the two volumes. Pyrophyllite has been utilized exclusively for support, and when it is also used as the cell material, the low Bi transitions usually occur at 110-130 tons of applied force. The all pyrophyllite system serves as a comparative reference. When BN is placed in the high-pressure cavity, the Bi transitions are not generally observed until the press load reaches 140-160 tons. The comparative data yield the relative compressibility, and in this case shows that BN is more compressible than pyrophyllite. Strong (3) has reported an analogous behavior for the "Belt" apparatus.

material is shown in Fig. 7. The more linear nature of the BN response is evidence of the compressibility behavior just discussed. This suggests that BN might be superior, with respect to economy of applied force, than either pyrophyllite or talc at pressures above 60 kb.

Pyrophyllite was again less uniform in its response than the other two materials. While one sample showed a shear strength only slightly greater than the talc specimens, the other two gave the largest observed difference between the two calibration circuits of any of the experiments. The Ba points on the last specimen tabulated were 12 percent apart. This is a difference of 6.6 kb or about 94,000 psi at this pressure. The lava was selected on the basis of the visual and machinability criteria mentioned previously.

Talc gave results which fell between the two previously mentioned materials. The last sample listed in Table 3 was the best, reaching the Ba transition at a lower tonnage than at any of the nine runs made.

It is interesting to note that in over half the specimens run, the percentage difference between the Tl points was greater than that found at the Ba transitions. Apparently the materials flow more easily at higher pressures. The maximum resistance to flow appears to be in the neighborhood of 40 kb.

Secondly, some mention should be made of attempts to evaluate the errors present in this method of studying shear strength. Since AgCl is the accepted reference with respect to pressure-transmitting qualities above 30 kb, an experiment



was conducted using this material for essentially the entire cell. Both faces and the cylindrical surface of the AgCl were covered with 15-mil lava in an effort to prevent extrusion of this highly fluid material. Although the Bi and Tl transitions were achieved, a "blowout" of the AgCl from the sample cavity occurred before the Ba point was reached. In the transitions recorded, however, there was no discernible difference between the normal and parallel calibration circuits.

Another source of possible error was believed present in the use of wire for the annular circuit. For the specimens placed parallel to the axis, the response is dependent primarily upon the pressure which the surrounding media transmits in a radial direction. The wire placed at 90 deg to this, however, although mainly sensitive to pressure in the thrust direction, still has a relatively large area normal to the circumference due to the thickness of the Ag Cl ring. It was considered that this circuit might respond to pressure intermediate between that in the two directions under study. Consequently, an experiment was performed using an essentially two dimensional sensing element; i.e., thin strip (0.004 in.) between thin disks of AgCl. This was done with Bi-Tl and run simultaneously with a sensing cell of standard construction. No difference was observed between the values obtained from the two configurations.

A greater uniformity of pressure obviously results from the use of AgCl around the sensing elements. The absence of this material, results in reduced sensitivity in detecting transitions and also greatly increases the problem of calibration cell assembly.

Finally, it should be noted that this work was confined to phenomena occurring at room temperature. Although the effect of the simultaneous generation of high temperatures and high pressures on stress distribution needs greater clarification, it would be naive to assume that work at ambient temperatures is not useful. A large variety of physical phenomena have been examined to 30 kb in hydrostatic apparatus. It is obvious that if work of this nature is to be extended to higher pressures, a greater understanding of flow in solid media must be attained.

#### SUMMARY

This paper has been an effort to collect and correlate data on the behavior of pyrophyllite, talc, and hot-pressed boron nitride to moderately high pressures. A summary of the major points of interest are as follows:

- 1 In cylindrical samples with a height-to-

width ratio of unity or less, axial-pressure gradients have been found to be minor. These gradients are dependent upon the surface friction between the cell material and apparatus components.

- 2 The region of highest pressure was at the center of the axis for all materials tested.

- 3 Increasing the height/width ratio by a factor of two introduces serious axial-pressure losses if proper lubrication is not provided. In this case, hot-pressed BN showed the lowest pressure loss due to its low surface friction.

- 4 An explanation is offered for the sluggish response of the low Bi transitions when the element is not embedded in AgCl. The behavior is explained on the basis of the ability of surrounding media to flow rapidly and maintain pressure on the Bi as it decreases in volume.

- 5 Based on observations of the Bi I-II and II-III transitions, indium shows no greater ability to flow than does AgCl.

- 6 The directional properties of hot-pressed BN effect its pressure transmitting properties to a limited extent at pressures in the neighborhood of 30 kb.

- 7 A technique for assembling calibration cells incorporating Bi, Tl, and Ba is described. The method permits observation of at least four fixed points with a single setup, and, based on performance to 60 kb, appears to be applicable for determination of the high Bi and Ba transitions if desired.

- 8 Hot-pressed BN exhibits less shear strength under actual experimental conditions than either pyrophyllite or talc.

- 9 The shear strength of the foregoing materials is not correlative with the ability to flow on a microscopic scale. This is shown by the superior performance of talc when used as the material surrounding calibration elements and the fact that in bulk specimens, BN transmits pressure more evenly.

#### ACKNOWLEDGMENTS

The authors take pleasure in acknowledging the assistance of Messrs. Arthur Henius, Fredrick Plock, and George Tomes in performing these experiments. Special thanks are given to Mr. Frank Becker of the Fabrication Division for his excellent support in machining parts for this work.

#### REFERENCES

- 1 F. P. Bundy, "Journal of Engineering for Industry," Trans. ASME, vol. 83, 1961, p. 207.
- 2 A. A. Giardini, J. E. Tydings and S. B. Levin, "American Mineralogist," vol. 45, 1960, p.



217, and U. S. Patent No. 2,995,776, August 1961.

3 R. H. Wentorf, Jr., "Modern Very High Pressure Methods," Butterworths, Washington, 1962.

4 A. Nadai, "Theory of Flow and Fracture of

Solids," vol. 1, McGraw Hill, New York, 1950.

5 F. R. Boyd and J. L. England, "Journal of Geophysical Research," vol. 65, no. 2, 1960, p.

741.